

S31

UNIVERSAL CYLINDRICAL GRINDING MACHINE



C.O.R.E.®





APPLICATIONS

STUDER S31 IN USE

From small to large workpieces. From single-part to volume production The S31 is a universal cylindrical grinding machine that can easily handle complex jobs. How would you like your machine? Thanks to the upgradeable modular system, the S31 can be adapted to match all your requirements.



S31

DIMENSIONS

- Distance between centers 400/650/1000/1600 mm (15.7"/25.6"/39.4"/63")
- Centre height 175 mm (6.9")
- Grinding wheel diameter 500 mm (20")

HARDWARE

- Turret wheelhead with either:
 - Stepless B axis
 - B axis with 1deg Hirth serration
- Frequency-controlled motor spindle for external and internal grinding
- C axis for the workhead, enabling form and thread grinding
- C.O.R.E. Panel
- Tool table with integrated double T-slot for dressing devices
- Full enclosure with two sliding doors
- Granitan® S103 mineral-casting machine base

SOFTWARE

- C.O.R.E. OS Operating system
- Very simple programming thanks to Studer-Pictogramming
- Reduced set-up and resetting times with STUDER QuickSet
- High-Speed-Machining (HSM) for efficient and high-precision form grinding
- Standardized interfaces for loader and peripheral devices
- Flexibly upgradeable with integrated software modules
- StuderWINprogramming software (optional) for creating grinding and dressing programs on an external PC

YOUR BENEFIT

- Short processing time thanks to complete machining
- Highest precision thanks to perfect interaction of hardware and software
- Intuitive, user-oriented and efficient operation
- Access to important information directly at the panel (e.g. production progress, job details, etc.)
- Reduced programming effort during data exchange between C.O.R.E. machines
- Use of UNITED GRINDING Digital Solutions™ products directly on the machine
- Fast support thanks to direct interaction with our Customer Care team on the machine
- Ecological thanks to targeted measures for lower energy consumption
- Ergonomic thanks to large sliding doors and three service doors

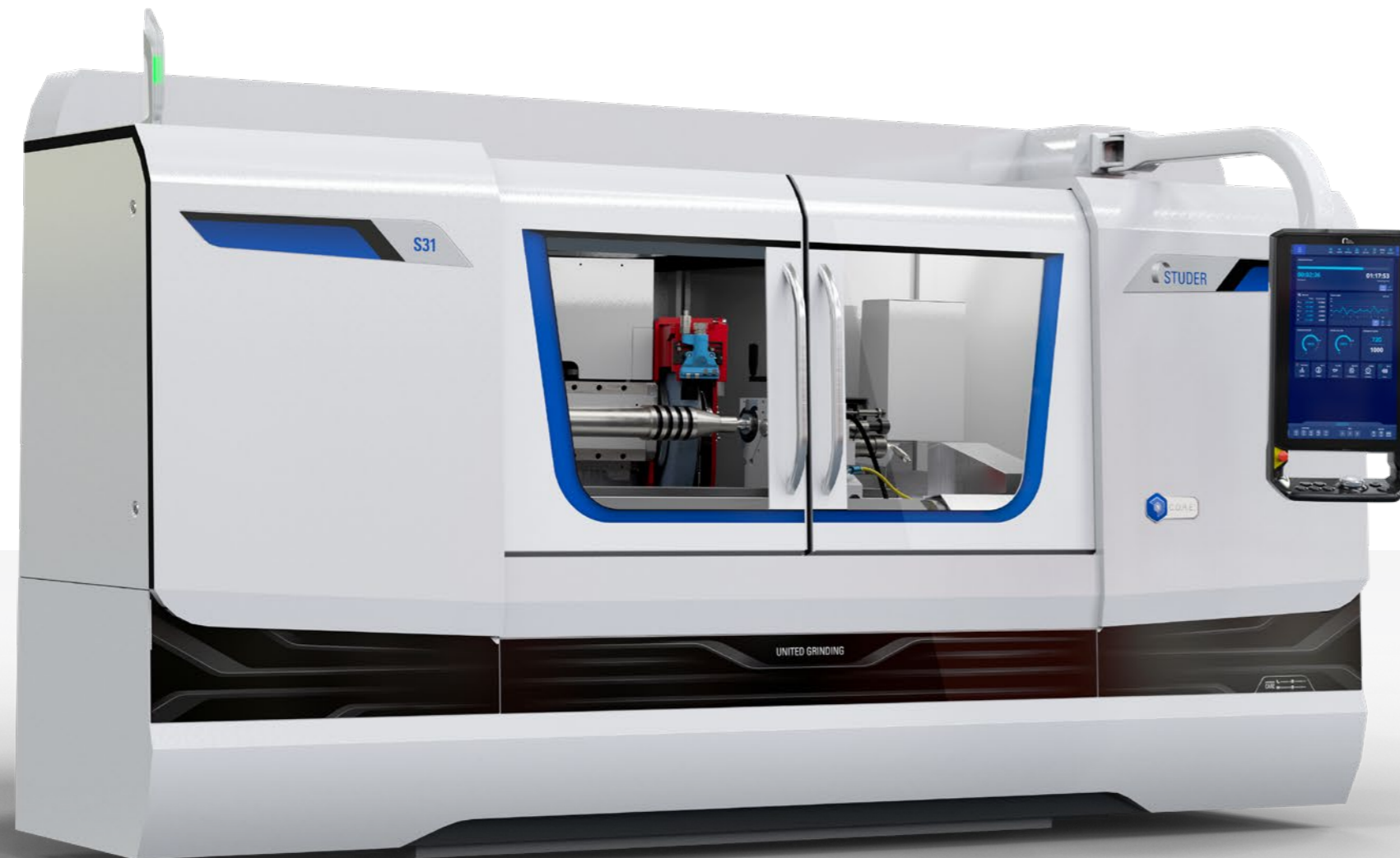

«The versatile
for big tasks.»

C.O.R.E. – CUSTOMER ORIENTED REVOLUTION

C.O.R.E. helps us make your production fit for the digital future.

It's based on a new operating system, C.O.R.E. OS that equips the machine with intelligence.

Thanks to the uniform C.O.R.E. software architecture, exchanging data between UNITED GRINDING machines is easy. The integrated umati API can be used to communicate with third-party systems as well. It also offers access to UNITED GRINDING Digital Solutions™ products directly on the machine. C.O.R.E. not only establishes the technical foundation for this and other IoT and data applications, it also forms the basis of revolutionary yet uniform operation.

What does this mean for you?

- The user-friendly, intuitive, and uniform operation makes work easier for machine setters, machine operators, and maintenance staff
- Standardized data collection and intelligent processing of data creates transparency and supports process optimization
- The uncomplicated and consistent use of modern digital software solutions is guaranteed – directly on the machine
- The technical platform for the use of modern IoT and data applications has been established

C.O.R.E. ELEMENTE

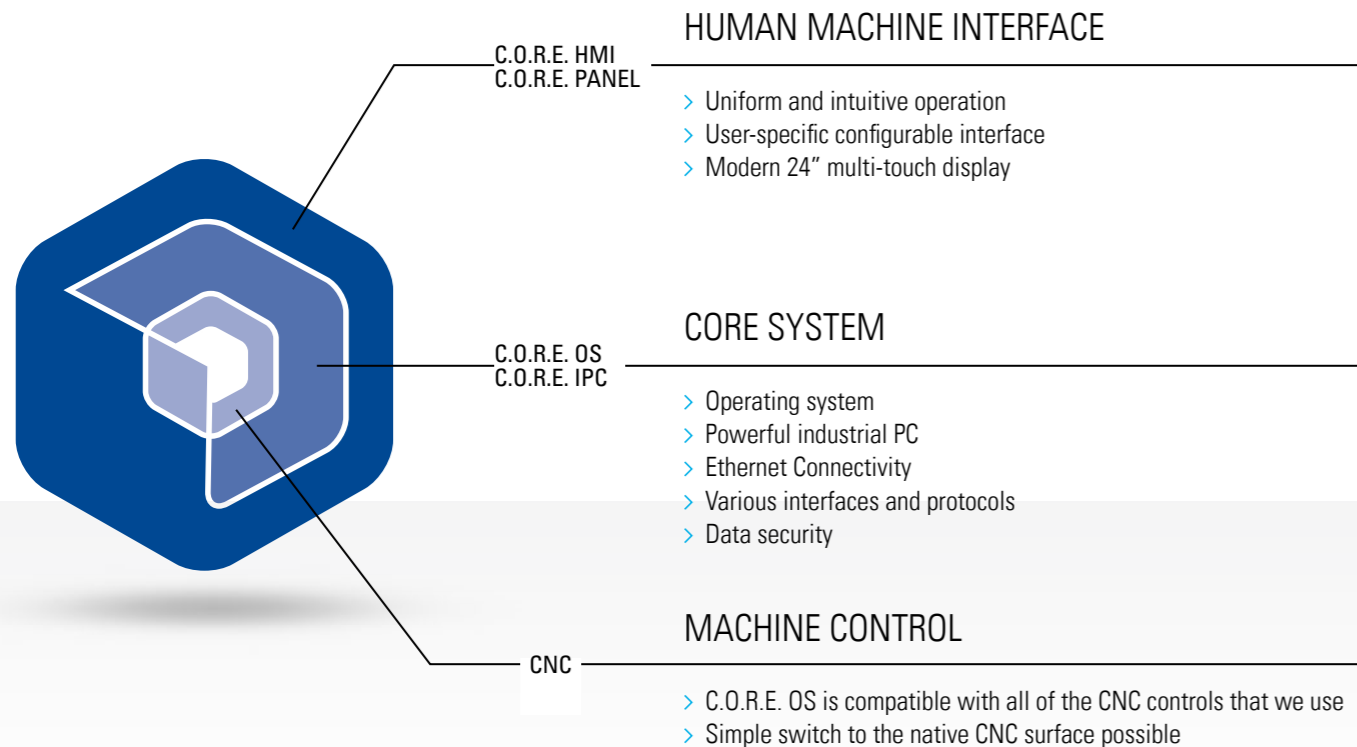

C.O.R.E. PANEL – THE FUTURE OF OPERATION

Intuitive

Thanks to intuitive design with self-explanatory icons, navigation through the machine menu and process steps is quick and easy. Instead of buttons, the user is presented with a modern and clearly arranged multi-touch display.

User-friendly

Each user configures their own user interface individually. This is called up automatically with the RFID chip after logging in. When the user leaves the machine, the panel switches to «Dark Factory Mode.» Production progress and the machine state are also clearly visible from a

distance. And thanks to the ergonomic design, the panel can be tilted and individually adjusted easily.

Efficient

The uniform and intuitive operating philosophy reduces training time. The configurable and role-specific interface helps prevent errors and increases the efficiency and quality of programming. Information can be exchanged quickly and in real-time via the front camera and Bluetooth headset. UNITED GRINDING Digital Solutions™ products can be used directly on the panel.

INDUSTRIAL MULTI-TOUCH DISPLAY

INTEGRATED FRONT CAMERA

SELF-EXPLANATORY ICONS

USER-CONFIGURABLE DISPLAY

STANDARDIZED FUNCTION KEYS

ERGONOMIC OVERRIDE SWITCH



Technical Specifications

- 24" Full HD multi-touch display
- 16-position rotary override switch
- Electronic key switch (RFID)
- Integrated front camera
- Bluetooth V4.0 for headset connection
- 2x USB 3.0 ports
- Adjustable tilt

USER INTERFACE

StuderWIN

The user interface StuderWIN creates a stable programming environment and contributes to efficient use of the machine. The possibility of fully integrating the in-process gauging and sensor technology for process control as well as contact detection and automatic balancing systems in the operator interface enables standardized programming of the different systems.

The software of an optional loading system is also integrated. The drive elements are optimally matched to the control system. The sophisticated mechanical engineering concept of the S31 is completed by a grinding software program developed in-house by STUDER and which is continuously optimized in collaboration with users of the software. This software offers:

- StuderPictogramming: The operator strings the individual grinding cycles together – the control generates the ISO code.
- STUDER QuickSet: The software for grinding wheel alignment reduces resetting times by up to 90%.
- Microfunctions: Free programming of grinding and dressing process sequences for optimization of the grinding process.
- Integrated operating instructions assist safe machine operation.

- The software options for the grinding technology calculations, optimized dressing as well as the Contour-, Thread- and Formgrinding cycles increase the functionality of the machine.

More than 100 years of know-how

StuderTechnology integrated radically simplifies the operation of cylindrical grinding machines. Component quality, machining time, energy efficiency, in short: All key production factors benefit enormously. What makes this software so unique? Its history! It incorporates more than 100 years of grinding experience. It is a combination of formulas from grinding technology, empirical data and many years of expertise. The program contains data from countless grinding tests, in which the best machining strategy has been determined for a wide variety of components. StuderTechnology integrated specifically refers to these values depending on the application. This integrated grinding know-how can be further optimized as required by the individual grinding expert and stored as a customer-specific production specification. This also enables inexperienced grinders to benefit from specialist knowledge.

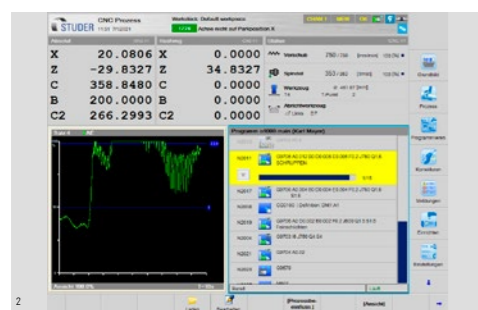
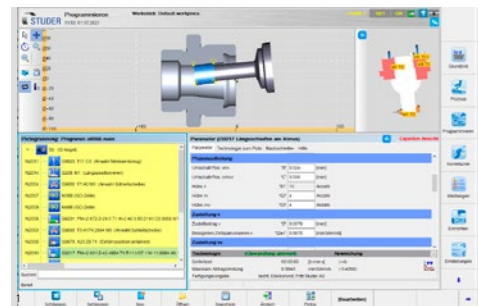

1 Programming interface with StuderPictogramming
2 Process screen
3 External programming station



Integrated Tools

Thanks to the many different extension packages, the functionality of STUDER grinding machines can be considerably enhanced. STUDER offers the necessary software packages in the form of Integrated Tools.

- **StuderDress Integrated** reduces the profiling time of a grinding wheel by up to 80%.
- **StuderThread Integrated** together with the Studer thread grinding cycles, offers the full functionality that is otherwise only possible on a special thread grinding machine.
- **StuderContourBasic Integrated** is for anyone who wants to trace any geometry contour with the grinding wheel easily, quickly and safely.
- **StuderContourPRO Integrated** generates the complete grinding program for complex external geometries, typically for peel grinding from solid.
- **StuderForm Integrated** is the universal noncircular grinding software for machining of curves and polygons for standard applications in small production runs.
- **StuderFormHSM Integrated** makes the noncircular grinding process manageable even with highly dynamic process requirements and is used in both individual component and large-scale production.
- **StuderCoordinate Integrated** as been developed for highly eccentric internal geometries such as coordinate holes and, in combination with the cylindrical and form grinding cycles, enables the complete machining of complex components in a single clamping.

LaserControl™

Contactless measurement directly on the machine when machining precision workpieces. Not only various large «non-interrupted» workpiece diameters can be precisely measured contact-free with the laser measuring, but also «interrupted» diameters such as shafts with splines or grooves, cutting edges of tools, tool flutes as well as the external diameters of gears. The STUDER-Software records the measured values after each measuring cycle.

TouchControl™

Workpieces are inspected directly on the machine, the results are recorded and corrections are transferred to the control system.

- Flexible diameter and length control measurement using a touch probe
- Seat- and tool-specific calculation of dimensional deviations
- Logging of post-process control data
- Programmable cycle for automatic calibration of the touch probe to reference diameter or length

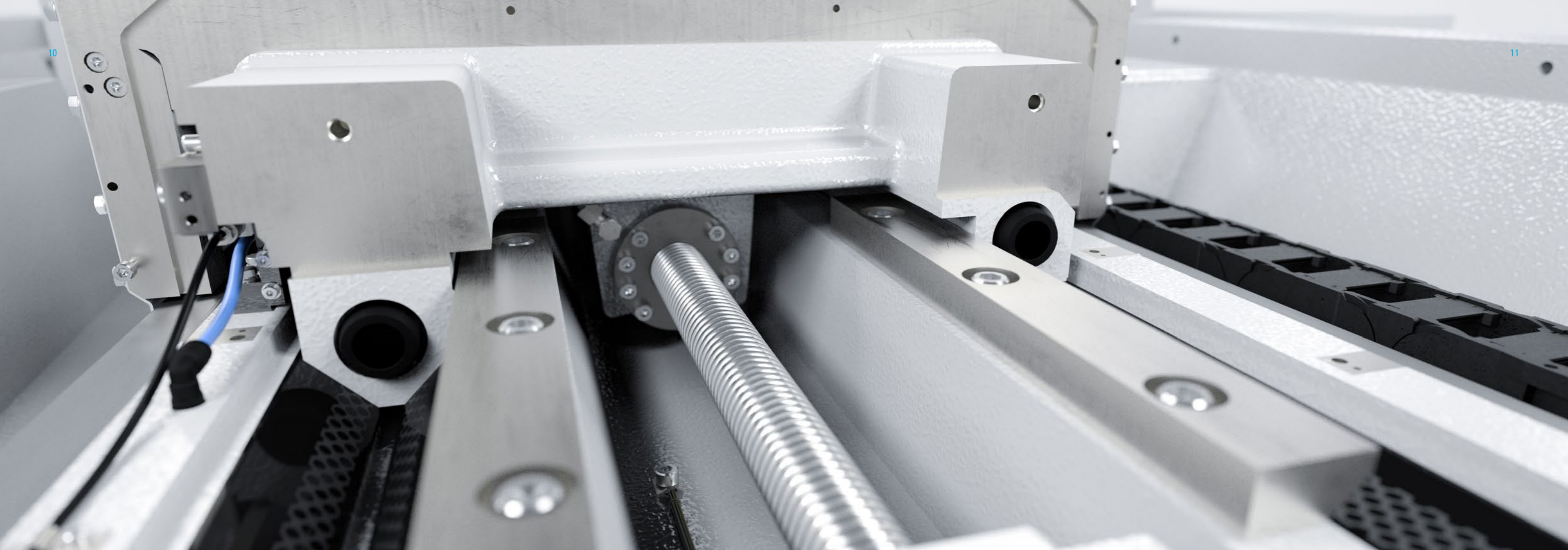

GRANITAN® S103 MINERAL CASTING MACHINE BED

The material structure developed by STUDER which has proved its superb efficiency over many years is produced in the company's own plant using the most modern industrial techniques. The excellent dampening behavior of the machine base ensures outstanding surface quality of the ground workpieces. The service life of the grinding wheel is also increased, leading to reduced downtimes. Temporary temperature fluctuations are extensively compensated by the favorable thermal behavior of Granitan®. This provides high stability throughout the day. The StuderGuide® guide system for the longitudinal and cross slides is moulded directly into the machine base and finished with a wear-resistant Granitan® S200 surfacing material. The guideways offer the highest possible accuracy through the entire speed range with high load capacity and dampening levels. Thanks to the robust and maintenance-free design, these excellent guideway characteristics are more or less completely retained.

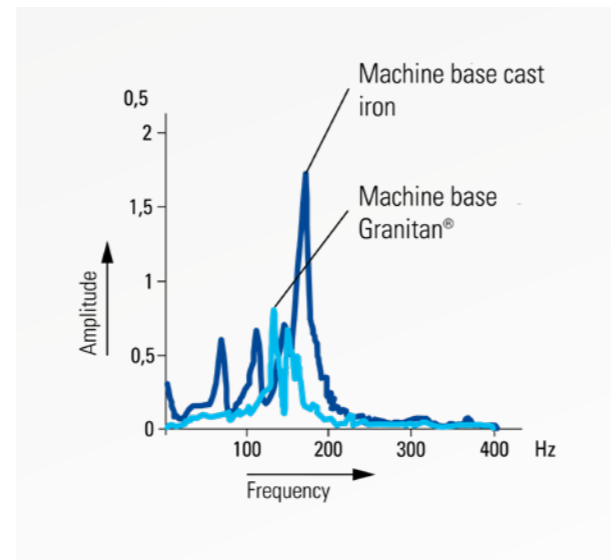

- Vibration-dampening
- Thermally stable
- Non-wearing

STUDERGUIDE® IN LONGITUDINAL AND CROSS SLIDES

The longitudinal and cross slides are manufactured from high-quality gray cast iron and have highly precise, ground guideways. The slides rest completely on the guideways of the machine bed through the entire traversing range. This provides the cornerstone for the excellent straightness of 0.003 mm over 950 mm measured length. The top of the longitudinal slide has a surface that is ground over its entire length and acts as a support for the workhead, the tailstock, as well as accessories and devices. A setup scale, recessed in the table, makes it easy to set up and reset the units on the table.

An additional T-slot with a ground surface enables the optimal utilization of dressing devices. The newly developed StuderGuide® guide system extends the advantages of hydrostatic systems and guideways with patented surface structure. A huge advantage of StuderGuide® over hydrostatic guideways is the damping component in the movement direction. The slides are advanced by circulating ball screws connected to a three-phase servomotor via torsion-resistant, below couplings. These axes achieve high process speeds, on the one hand, while on the other hand the short auxiliary times also guarantee maximum precision with in-feed movements of 0.0001 mm.

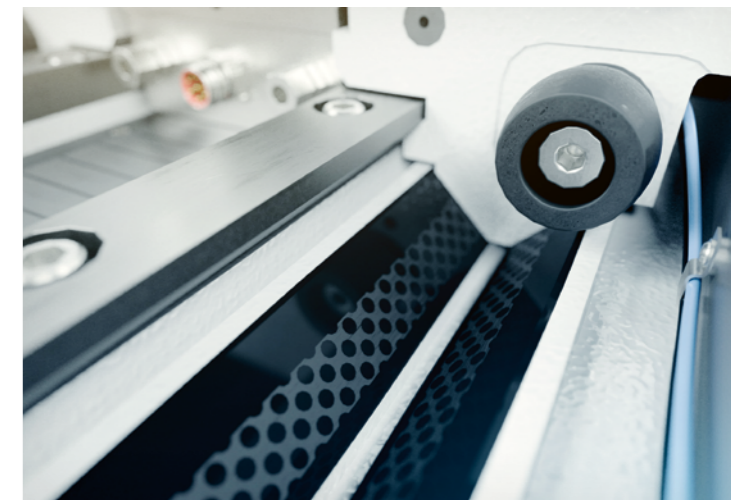

- High geometrical traverse precision
- Effective protection of guideways
- Auxiliary scale for set-up and resetting

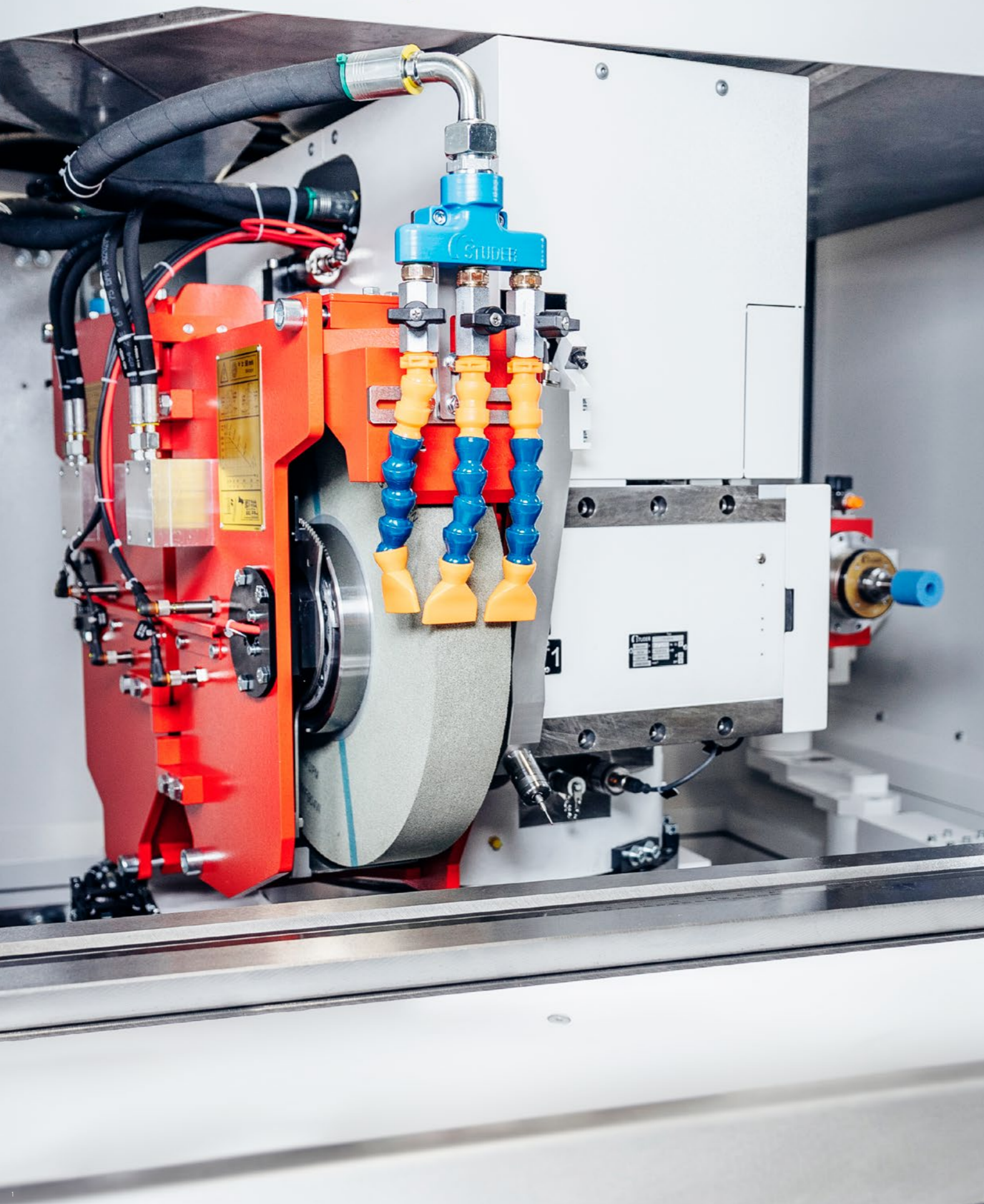
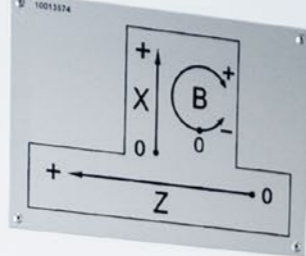

WHEELHEAD

Reduce set-up and resetting costs? This is possible with this machine, especially in single-part or small-batch production. This is made possible by the turret wheelhead with several grinding wheels and Quick-Set for rapid set-up. Boost efficiency with complete machining in a single clamping. The S31 handles internal, external, and face grinding with ease.

The direct drive on the B axis with high-resolution direct measuring system offers you valuable support. It allows for the grinding of various diameters and any tapers using the same grinding wheel without intermediate dressing. It also guarantees a repetition accuracy in the high-precision B axis of $<1''$. Or, as an alternative, you can configure the wheelhead with a 1° Hirth serration and automatic swiveling.

The swiveling wheelhead is equipped with water-cooled, roller-based, and maintenance-free motor spindles with stepless speed control and the latest generation of contact sensors. The shaft ends hold external wheelheads with a diameter of 500 mm (20") and a width of 63 mm / 2.48" (80 F5 / 3.15" F5). For internal grinding, use powerful high-frequency spindles with 120 mm (4.72") external diameter. It's your choice: configure the wheelhead to match your specific needs.

- Complete machining
- Motor spindles
- High cutting speed of up to 63 m/s (12398 sfpm)
- 3 tools (2× external, 1× internal or 1× external, 2× internal)

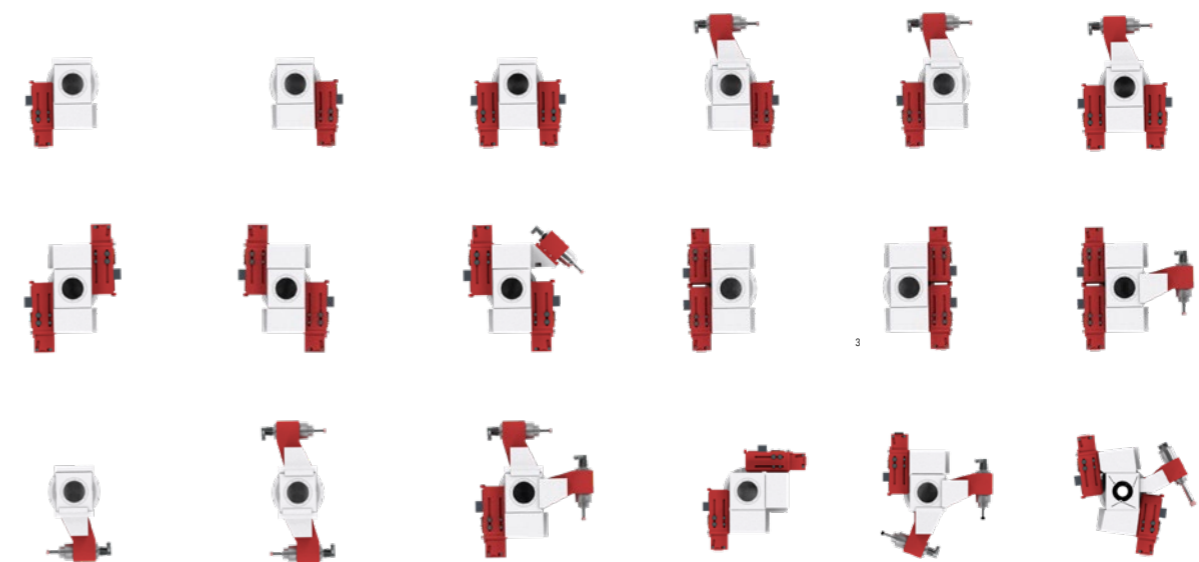
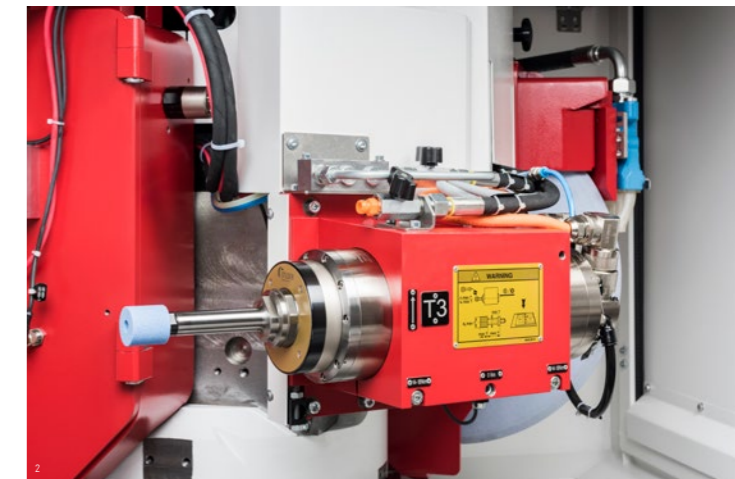

- 1 Turret wheelhead
- 2 Select wheelhead variants
- 3 Internal grinding attachment

WORKHEAD

A wide range of workheads covers all requirements. These are all sturdily built in the highest STUDER quality and achieve a roundness accuracy during live grinding of 0.0004 mm and optionally even 0.0002 mm. Easy cylindricity correction helps to achieve perfect results during live grinding. Customer-specific workpiece clamping and driving systems can be easily used.

- High roundness accuracy
- Low-maintenance
- Air cushion

Universal workhead

For external grinding with a fixed center or for live grinding. The spindle is locked for grinding between fixed centers. C-axis applications are possible with an indirect measuring system.

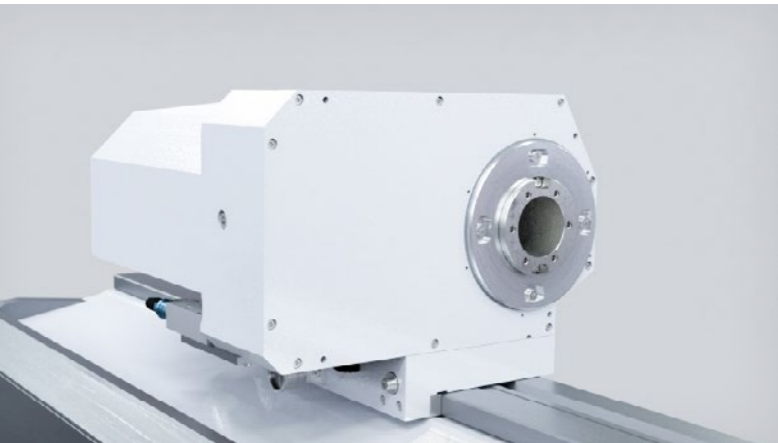

Chuck workhead

For live grinding or external grinding with revolving center. Thanks to the design, with drive via a belt at the back, high loads are possible during live grinding. For high-precision C-axis applications a measurement system can be mounted directly on the spindle.

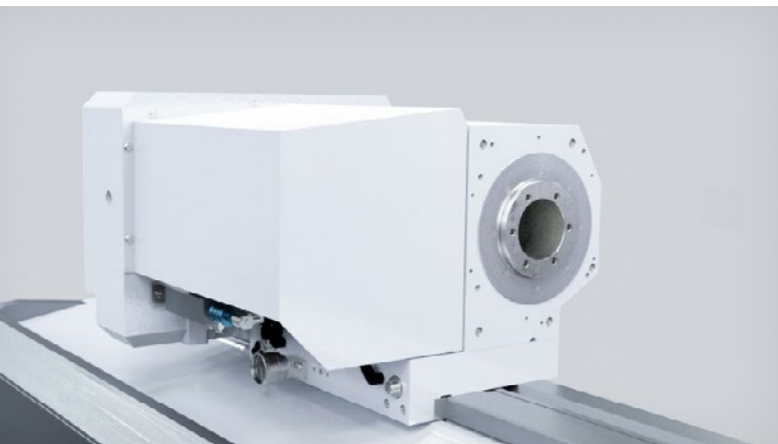

C-AXIS FOR FORM AND THREAD GRINDING

Complete machining also entails form and thread grinding operations to an ever increasing extent. These processes are made possible by the position and speed-controlled C-axis. The standard C-axis with measuring system on the drive motor is suitable for thread grinding. A direct measuring system is mounted on the workhead spindle (C-axis) to ensure the highest form accuracy). Acceleration and grinding forces are absorbed without difficulty through the high dynamic rigidity of the axis drives.

Form and thread grinding

The S31 enables axis-parallel grinding of conventional threads up to threads for high accuracy application. Polygons, excenters, control cams, cams etc. can be manufactured costeffectively and in the highest precision with High Speed Machining (HSM).



TAILSTOCK

The generously dimensioned barrel, designed for the deployment of Morse 4 taper centres, glides in the tailstock housing. The centre pressure can be adjusted with the delicate precision required for grinding high-precision workpieces. The tailstock can be equipped with a hydraulically actuated barrel retraction for workpiece changeover. The fine adjustment enables cylindricity corrections in the range below 1 µm

when grinding between centres. An air cushion lift-off facilitates simple movement during setup and resetting. A cooling lubricant is passed through the tailstock and totally covers the barrel and diamond holder, in order to guarantee optimum thermal stability.

Tailstock

Clamping is by means of a spring. This tailstock is suitable for workpiece weights up to 150 kg.

Synchronous tailstock

Use of the synchronous tailstock is particularly cost-effective when manufacturing part families, when grinding a workpiece over its entire length or if the use of a conventional driver is not possible. Workpiece weight up to 80 kg.

- Cylindricity corrections
- Thermal stabilization

DRESSING

An easy-cutting grinding wheel is essential for cost-effective and high-quality grinding. STUDER offers a large selection of dressing units, in order to coordinate the dressing process flexibly and optimally with the properties specific to the workpiece, tool or materials. The grinding wheel profile and dressing parameters are easily defined via macros. Another STUDER speciality is the grinding wheel reference points

(T-numbers). This enables programming with normal dimensions, which considerably simplifies the programming of grinding programs.

A software package is available to fine tune the dressing process and includes additional dressing functions.

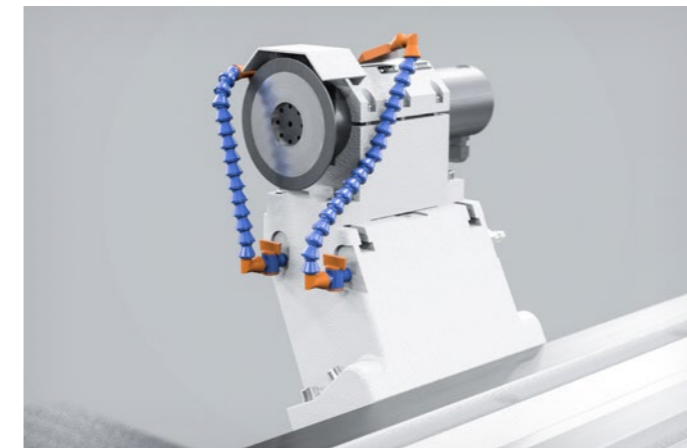

Rotational dressing

Rotating dressing tools are particularly suitable for dressing CBN and diamond grinding wheels.

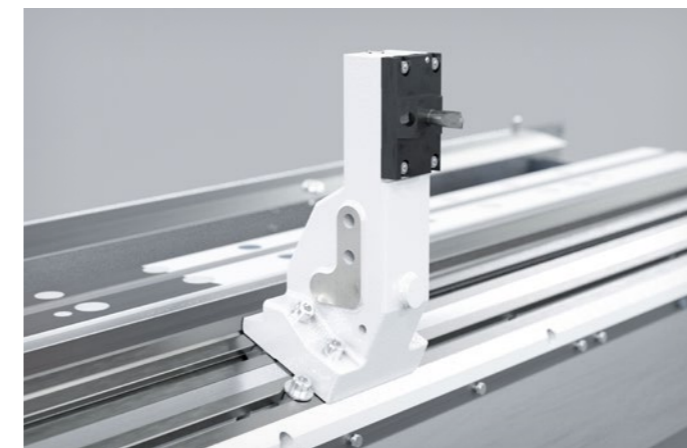

Diamond holder behind tailstock

The clamping surface with double T-slot can accommodate various dressing tools.

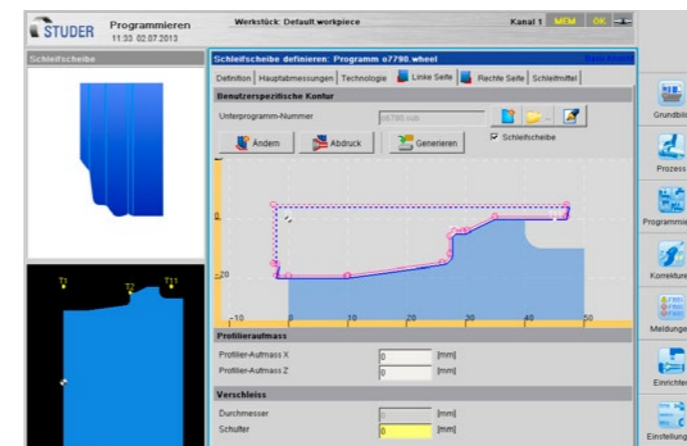

Dressing parameters dialog screen

Easy creation of free grinding wheel shapes with grinding wheel impression from workpiece drawing.

AUTOMATION

Several loading systems are available for the S31. From the cost-effective easyLoad, which is operated via the machine control, to the easyLoad NC with its own control unit, through to special solutions which can be precisely adapted to the machine application and machining processes, thanks to their modular design. A Datamatrix code reader or a laser marking system ensures that each workpiece receives its own identity, and process data can be traced at any time. The appropriate peripherals ensure seamless integration into the respective production

process. Project-specific components such as e.g. pre- and post-process stations, brushing and blow-off stations, calibration part trays etc. can be implemented in the system. The handling systems communicate with the machine via the standardized loader interface and enable even complex handling tasks to be solved. Comprehensive quality control is possible during the grinding process. This entails: in-process, post-process, recording, evaluation and correction. This type of quality assurance is crucial during grinding, but especially during match grinding.



CUSTOMER CARE – WE ARE HERE FOR YOU!

Our products are designed to meet customer demands for as long as possible, they are intended to operate efficiently, reliably, and be available at any time.

From «Start up» through to «Retrofit» – our Customer Care is there for you throughout the working life of your machine. That is why over 200 competent service contacts worldwide in 10 spoken languages are available locally.

- We will provide you with fast, straight-forward support.
- We will help to increase your productivity.
- We work professionally, reliably and transparently.
- We will provide a professional solution to your problems.

UNITED GRINDING DIGITAL SOLUTIONS™

We develop solutions to support you in simplifying processes, boosting your machines' efficiency and increasing overall productivity under the «UNITED GRINDING Digital Solutions™» brand.

We are continuously expanding our solution portfolio in the key areas of CONNECTIVITY, USABILITY, MONITORING, and PRODUCTIVITY to make your work in the digital age significantly easier.

Find out more about UNITED GRINDING Digital Solutions™ services on our website in the Customer Care section.



Start up
Commissioning
Warranty extension



Qualification
Training
Production support



Prevention
Maintenance
Inspection



Service
Customer service
Customer consultation
HelpLine



Digital Solutions
Remote Service
Service Monitor
Production Monitor

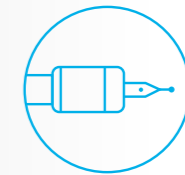

Material
Spare parts
Replacement parts
Accessories



Rebuild
Machine overhaul
Assembly overhaul



Retrofit
Modifications
Retrofits

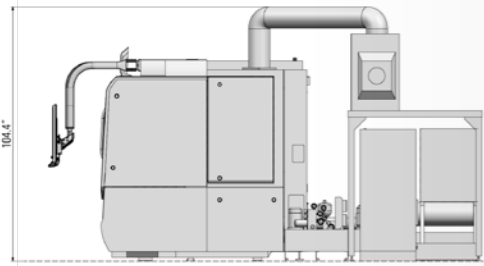
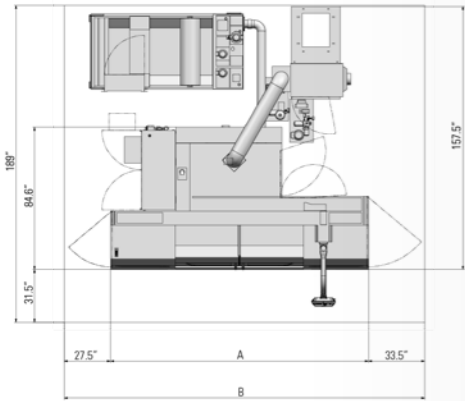

A B

| | | |
|-------------------------------|------|------|
| Distance between centres 400 | 2200 | 4500 |
| Distance between centres 650 | 3200 | 5200 |
| Distance between centres 1000 | 3900 | 5900 |
| Distance between centres 1600 | 5100 | 7100 |

TOTAL WEIGHT

| | |
|--|------------------------|
| Distance between centres 400 mm (15.7") | 8500 kg (18 700 lbs) |
| Distance between centres 650 mm (25.6") | 9500 kg (20 900 lbs) |
| Distance between centres 1000 mm (39.4") | 10 500 kg (23 150 lbs) |
| Distance between centres 1600 mm (63") | 12 000 kg (26 500 lbs) |

The information given is based on the technical levels of our machine at the time of this brochure going to print. We reserve the right to further develop our machines technically and make design modifications. This means that the dimensions, weights, colours, etc. of the machines supplied can differ. The diverse application possibilities of our machines depend on the technical equipment specifically requested by our customers. The equipment specifically agreed with the customer is therefore exclusively definitive for the equipping of the machines, and not any general data, information or illustrations.

TECHNICAL DATA

MAIN DIMENSIONS

| | |
|---------------------------------------|---|
| Distance between centres | 400 / 650 / 1000 / 1600 mm (15.7" / 25.6" / 39.4" / 63") |
| Centre height | 175 mm (6.9") |
| Max. workpiece weight between centres | 80 / 150 kg (176 / 330 lbs) |

CROSS SLIDE: X AXIS

| | |
|-------------|---|
| Max. travel | 370 mm (14.6") |
| Speed | 0,001 – 15 000 mm / min (0,000,04 – 590 ipm) |
| Resolution | 0,00001 mm (0,000,000,4") |

LONGITUDINAL SLIDE: Z AXIS

| | |
|-------------|---|
| Max. travel | 500 / 800 / 1150 / 1750 mm (19.7" / 31.5" / 45.3" / 68.9") |
| Speed | 0,001 – 20 000 mm / min (0,000,04 – 787 ipm) |
| Resolution | 0,00001 mm (0,000,000,4") |

WHEELHEAD

| | |
|--|---|
| Swiveling range | -30 to +225 deg |
| Resolution | 1 deg Hirth |
| Fitting taper | dia. 73 mm (2.87") |
| Driving power: | max. 11,5 kW (15.6 hp) |
| Grinding wheel, Ø×width×bore | 500×63 (80F5)×203 mm 20"×2.5" (3.15"F5)×8" |
| Circumferential Speed | standard up to 50 m / s (9840 sfpm) Option up to 60 m/s (12398 sfpm) |
| Internal grinding device for high frequency internal grinding spindles | |
| Spindle dia. | dia. 120 mm (4.73") |
| Speeds | 24 000 – 120 000 rpm |

Option: Direct drive

| | |
|---------------------|-------------|
| Resolution | 0,00005 deg |
| Repetition Accuracy | < 1" |

CONTROL UNIT

Fanuc Oi-TF

Option for HSG: Fanuc 31i-B

GUARANTEED WORKING PRECISION

| | |
|----------------------------------|-----------------------|
| Surface straightness | |
| Measuring length 400 mm (15.7") | 0,0020 mm (0,000,08") |
| Measuring length 650 mm (25.6") | 0,0025 mm (0,000,10") |
| Measuring length 1000 mm (39.4") | 0,0030 mm (0,000,12") |
| Measuring length 1600 mm (63") | 0,0040 mm (0,000,16") |

CONNECTED LOAD

| | |
|----------------------|------------------------|
| Total connected load | 20 kVA |
| Air pressure | 5,5-7 bar (80-102 psi) |

UNIVERSAL WORKHEAD

| | | |
|---|---|---|
| Speed range | 1 – 1500 rpm | 1 – 1500 rpm |
| Fitting taper | MT4 / dia. 70 mm (2.7") | MT5 |
| Spindle feedthrough | dia. 26 mm (1.02") | dia. 30 mm (1.18") |
| Driving power | 3 kW (4 hp) | 3 kW (4 hp) |
| Load during live grinding | 70 Nm (52 ft lbs) | 70 Nm (52 ft lbs) |
| Roundness accuracy during live grinding | 0,0004 mm (0,000,016") (Option: 0,0002mm / 0,000,008") | 0,0004 mm (0,000,016") (Option: 0,0002mm / 0,000,008") |

| | | |
|---|---|---|
| Speed range | 1 – 1000 rpm | 1 – 1000 rpm |
| Fitting taper | MT5 / dia. 110 mm (4.3") | ISO50 / dia. 110 mm (4.3") |
| Spindle feedthrough | dia. 38 mm (1.5") | dia. 50 mm (1.97") |
| Driving power | 4 kW (5.4 hp) | 4 kW (5.4 hp) |
| Load during live grinding | 180 Nm (134 ft lbs) | 180 Nm (134 ft lbs) |
| Roundness accuracy during live grinding | 0,0004 mm (0,000,016") (Option: 0,0002mm / 0,000,008") | 0,0004 mm (0,000,016") (Option: 0,0002mm / 0,000,008") |

| | | |
|----------------------------------|------------|------------|
| C axis indirect measuring system | 0,0001 deg | 0,0001 deg |
|----------------------------------|------------|------------|

CHUCK WORKHEAD

| | | | |
|---|---|---|---|
| Speed range | 1 – 1500 rpm | 1 – 1000 rpm | 1 – 1000 rpm |
| Fitting taper | MT4 / dia. 70 mm (2.7") | MT5 / dia. 110 mm (4.3") | ISO50 / dia. 110 mm (4.3") |
| Spindle feedthrough | dia. 26 mm (1.02") | dia. 38 mm (1.5") | dia. 50 mm (1.97") |
| Driving power | 3 kW (4 hp) | 4 kW (5.4 hp) | 4 kW (5.4 hp) |
| Load during live grinding | 100 Nm (74 ft lbs) | 250 Nm (186 ft lbs) | 250 Nm (186 ft lbs) |
| Roundness accuracy during live spindle grinding | 0,0004 mm (0,000,016") (Option: 0,0002mm / 0,000,008") | 0,0004 mm (0,000,016") (Option: 0,0002mm / 0,000,008") | 0,0004 mm (0,000,016") (Option: 0,0002mm / 0,000,008") |

| | | | |
|----------------------------------|------------|------------|------------|
| C axis indirect measuring system | 0,0001 deg | 0,0001 deg | 0,0001 deg |
|----------------------------------|------------|------------|------------|

Option

| | | | |
|--|------------|------------|------------|
| C axis high-precision, direct measuring system | 0,0001 deg | 0,0001 deg | 0,0001 deg |
|--|------------|------------|------------|

TAILSTOCK

| | | | |
|--|------------------|------------------|------------------|
| Fitting taper | MT3 | MT4 | MT4 |
| Travel of barrel | 35 mm (1.37") | 35 mm (1.37") | 60 mm (2.36") |
| Diameter of barrel | 50 mm (1.97") | 50 mm (1.97") | 60 mm (2.36") |
| Fine adjustment for cylindricity corrections | ±40 µm (0.0016") | ±40 µm (0.0016") | ±80 µm (0.0032") |

SYNCHRONOUS TAILSTOCK

| | | | |
|--|--------------------|--|------------------|
| Fitting taper | MT4 | Fitting taper | MT3 |
| Travel of barrel | 120 mm (4.72") | Barrel stroke | 35 mm (1.37") |
| Spindle nose | dia. 70 mm (2.75") | Diameter of barrel | 50 mm (1.9") |
| Workpiece weight between centres | 80 kg (176 lbs) | Automatic fine adjustment for cylindricity corrections | ±40 µm (0.0016") |
| Fine adjustment for cylindricity corrections | ±80 µm (0.0032") | | |

EXTRA-FINE GRINDING TAILSTOCK

FRITZ STUDER AG

The name STUDER stands for more than 100 years of experience in the development and production of precision cylindrical grinding machines. «The Art of Grinding.» is our passion, highest precision is our aim and top Swiss quality is our benchmark.

Our product line includes both standard machines, as well as complex system solutions in high-precision cylindrical grinding for machining small and medium-sized workpieces. In addition we offer software, system integration and a wide range of services. As well as receiving a complete tailor-made solution the customer also benefits from our 100 years of know-how in relation to the grinding process.

Our customers include companies from the machine tool industry, automotive engineering, tool and die makers, the aerospace industry, pneumatics/ hydraulics, electronics/electrical engineering, medical technology, the watch industry and job order production. They value maximum precision, safety, productivity and longevity. As one of the market and technology leaders in universal, external, internal cylindrical and non-circular grinding, with 24,000 systems delivered, STUDER has stood for precision, quality and durability for decades. STUDER's products and services include hardware, software and a wide range of services in the pre- and after-sales sector.



UNITED GRINDING GROUP

The UNITED GRINDING Group is one of the world's leading manufacturers of precision machines for grinding, eroding, laser, measuring, and combination machining. With around 2500 employees at more than 20 manufacturing, service, and sales locations, the Group has a customer-oriented and effective organization.

With its company brands MÄGERLE, BLOHM, JUNG, STUDER, SCHAUDT, MIKROSA, WALTER, and EWAG as well as competence centers in the US and Asia, UNITED GRINDING offers a broad application knowledge, an extensive product portfolio and a complete array of services for surface and profile grinding, cylindrical grinding and tool machining. In addition, a competence center for additive manufacturing is operated under the IRPD brand.

«We want to make our customers even more successful.»

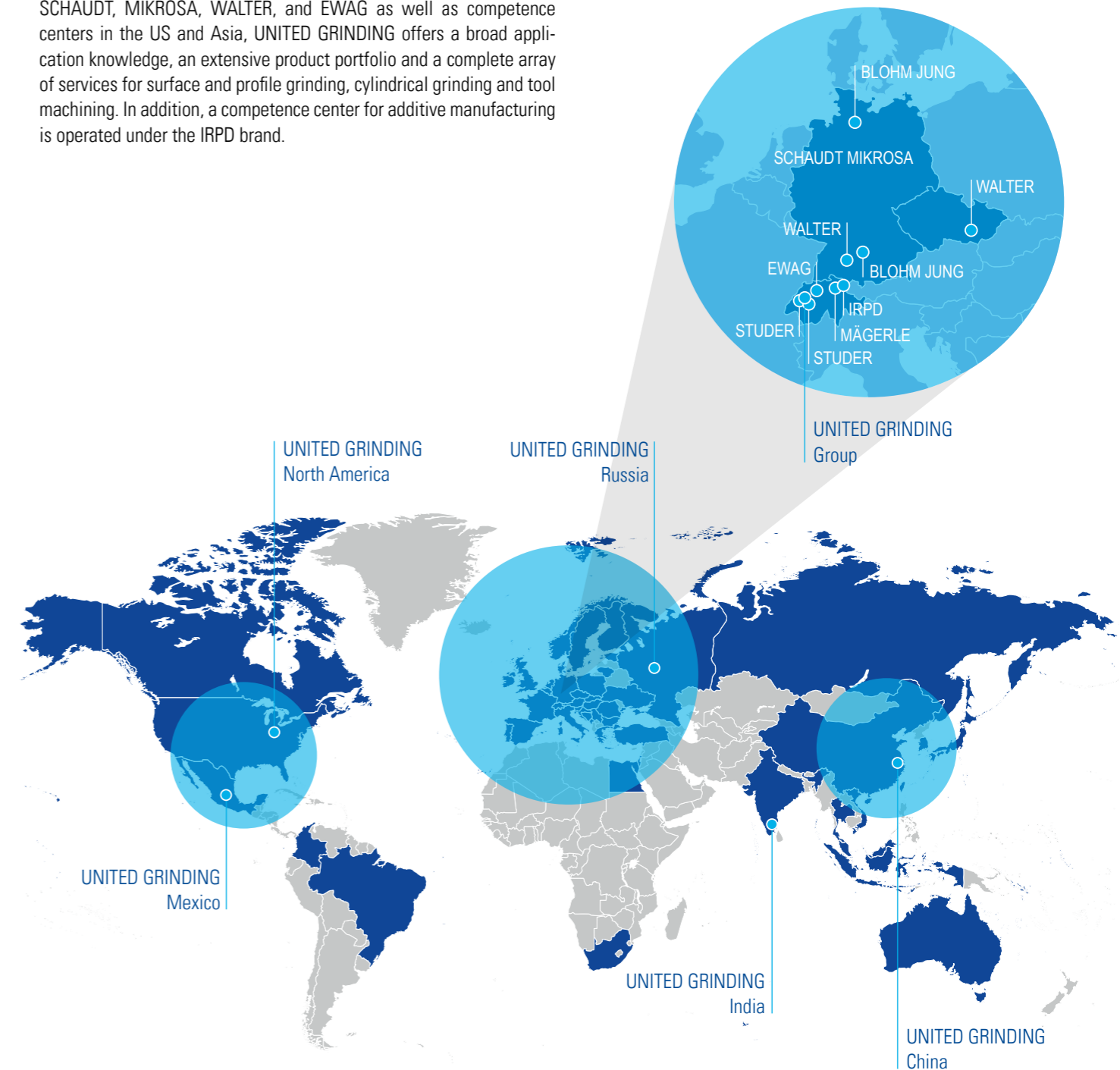



Fritz Studer AG
3602 Thun
Switzerland
Phone +41 33 439 11 11
info@studer.com
studer.com



ISO 9001
VDA6.4
certified

